



Cambridge IGCSE™

CANDIDATE
NAME

CENTRE
NUMBER

--	--	--	--	--

CANDIDATE
NUMBER

--	--	--	--



CO-ORDINATED SCIENCES

0654/61

Paper 6 Alternative to Practical

May/June 2020

1 hour 30 minutes

You must answer on the question paper.

No additional materials are needed.

INSTRUCTIONS

- Answer **all** questions.
- Use a black or dark blue pen. You may use an HB pencil for any diagrams or graphs.
- Write your name, centre number and candidate number in the boxes at the top of the page.
- Write your answer to each question in the space provided.
- Do **not** use an erasable pen or correction fluid.
- Do **not** write on any bar codes.
- You may use a calculator.
- You should show all your working and use appropriate units.

INFORMATION

- The total mark for this paper is 60.
- The number of marks for each question or part question is shown in brackets [].

This document has **16** pages. Blank pages are indicated.

1 Fig. 1.1 shows a flower.

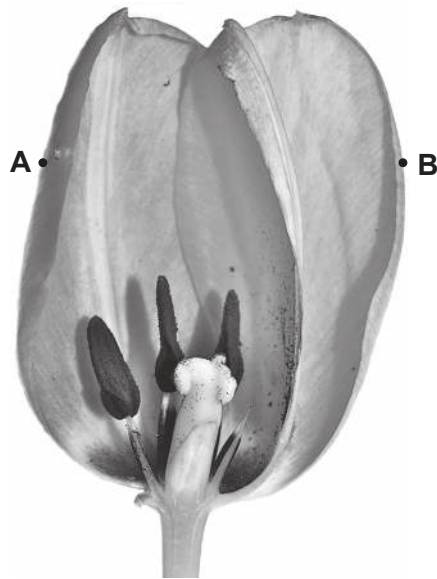
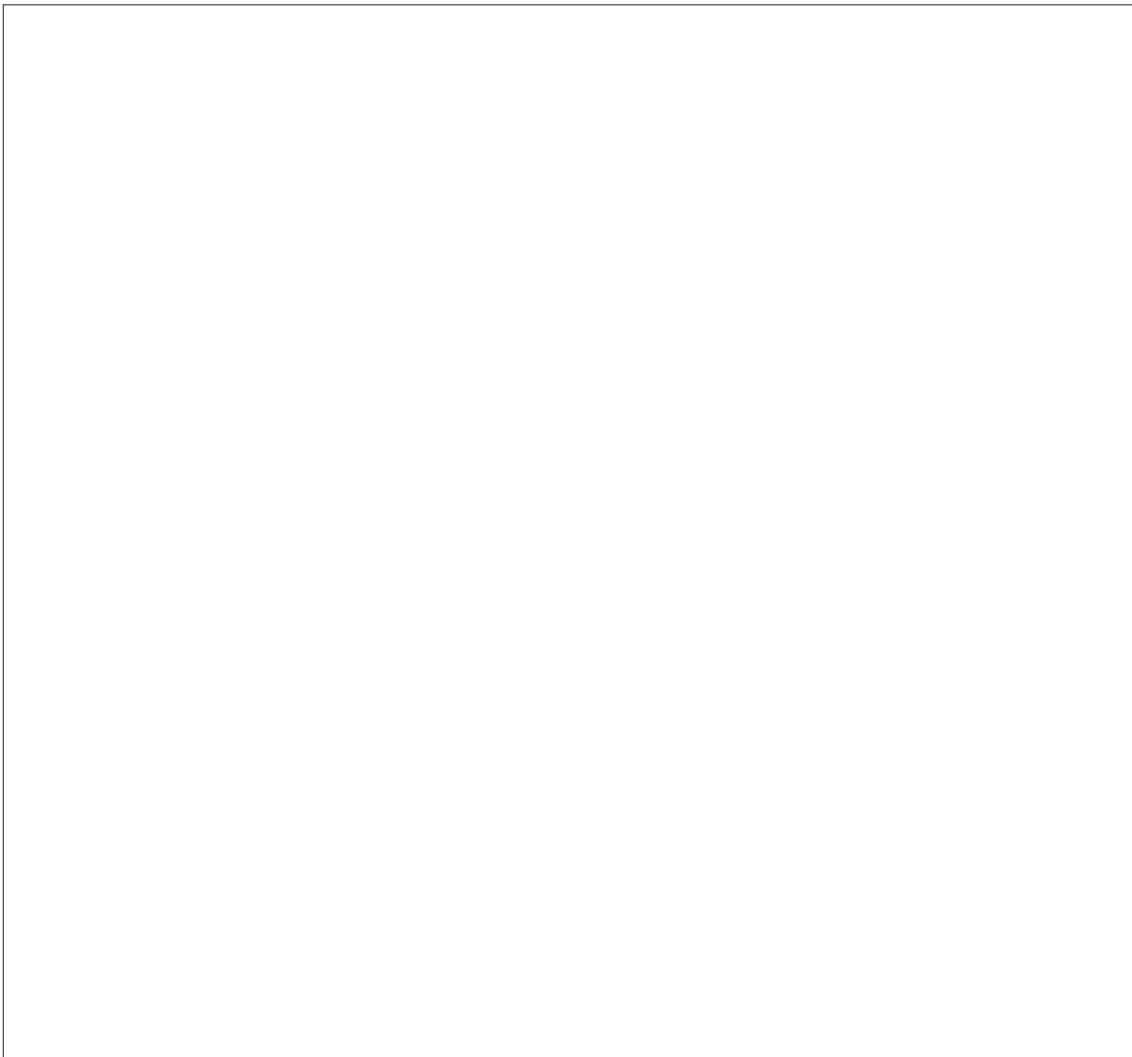

Fig. 1.1

- (a) (i) In the box, make an enlarged, detailed pencil drawing of the flower in Fig. 1.1.
Include the internal parts of the flower.



(ii) On your drawing, label an anther, a petal and a stigma. [3]

(b) Draw a straight line to join points **A** and **B** on Fig. 1.1.

(i) Measure the length of this line **AB** in millimetres to the nearest millimetre.

actual length of line **AB** on Fig. 1.1 = mm [1]

(ii) Mark the points **A** and **B** on your drawing in (a)(i).

Join these points with a line.

Measure and record the length of this line in millimetres to the nearest millimetre.

length of line **AB** on drawing = mm [1]

(iii) Use your measurements in (b)(i) and (b)(ii) to calculate the magnification m of your drawing.

Use the equation shown.

$$m = \frac{\text{length of } \mathbf{AB} \text{ on drawing}}{\text{actual length of } \mathbf{AB} \text{ on Fig. 1.1}}$$

Give your answer to two significant figures.

$m =$ [2]

[Total: 10]

2 A student has a sample of nectar and a sample of pollen from a flower.

She tests each sample using Benedict’s solution, biuret solution and iodine solution.

- The nectar gives a positive result with the Benedict’s solution.
- The pollen gives a positive result with the biuret solution.
- All other results are negative.

(a) Use this information to complete Table 2.1 with the final colours observed by the student.

Include the colours for negative results.

Table 2.1

sample	final colour with Benedict’s solution	final colour with biuret solution	final colour with iodine solution
nectar			
pollen			

[4]

(b) Use the results in Table 2.1 to state the nutrients present in the nectar and pollen.

nectar contains

pollen contains

[2]

(c) Describe how you would test the nectar for the presence of fat.

method.....

.....

observation for a positive result

[2]

(d) A student investigates the nutrient concentration in some samples of nectar and in some samples of pollen using Benedict’s solution.

Benedict’s solution will give a range of colours depending on the concentration of the nutrient for which it is testing.

State two variables which the student needs to control.

variable 1

variable 2

[2]

[Total: 10]

- 3 In this investigation a student is going to identify five solutions, **J**, **K**, **L**, **M** and **N**.

The names of the solutions are shown, but the student does not know which of these solutions are **J**, **K**, **L**, **M** and **N**.

aqueous ammonia

acidified aqueous barium nitrate

aqueous copper(II) chloride

aqueous sodium hydroxide

aqueous zinc sulfate

K is a blue solution.

All the other solutions are colourless.

- (a) Name solution **K**.

..... [1]

- (b) The student does four experiments to identify the solutions.

These experiments are shown in Table 3.1.

Table 3.1

experiment	method	observation
1	The student adds M slowly drop by drop until there is no further change to a sample of K .	light blue ppt. soluble in excess to give a dark blue solution
2	The student adds L slowly drop by drop until there is no further change to a sample of K .	light blue ppt. insoluble in excess
3	The student adds L slowly drop by drop until there is no further change to a sample of J .	white ppt. soluble in excess to give a colourless solution
4	The student adds J slowly drop by drop until there is no further change to a sample of N .	white ppt. insoluble in excess

- (i) Use the observations from experiment **1** to name solution **M**.

..... [1]

- (ii) Use the observations from experiment **2** to name solution **L**.

..... [1]

(iii) Use the observations from experiments 3 and 4 to name solutions J and N.

Explain how you arrived at your answer.

J

N

explanation

.....

.....

.....

.....

[2]

(c) Solid Q is ammonium carbonate.

A student adds dilute hydrochloric acid to Q in a test-tube.

Carbon dioxide gas is produced.

(i) Draw a labelled diagram of the assembled apparatus used to make and collect the carbon dioxide gas.

[2]

(ii) Describe a test to confirm the presence of ammonium ions in ammonium carbonate.

Include an observation for the positive result.

test

observation

[1]

[Total: 8]

- 4 A student investigates the temperature change when dilute hydrochloric acid is neutralised by aqueous sodium hydroxide.

The student:

- pours 10 cm^3 of aqueous sodium hydroxide into a glass beaker
- measures the temperature of the aqueous sodium hydroxide and records it in Table 4.1 to the nearest 0.5°C
- pours 5 cm^3 of dilute hydrochloric acid into the aqueous sodium hydroxide and stirs the mixture
- measures the highest temperature reached and records it in Table 4.1 to the nearest 0.5°C
- repeats the experiment using the volumes of dilute hydrochloric acid and aqueous sodium hydroxide shown in Table 4.1.

Some of the student's results are shown in Table 4.1.

Table 4.1

volume of dilute hydrochloric acid / cm^3	volume of aqueous sodium hydroxide / cm^3	temperature of aqueous sodium hydroxide in beaker / $^\circ\text{C}$	highest temperature of mixture in beaker / $^\circ\text{C}$	temperature change, ΔT / $^\circ\text{C}$
5	10	20.0	24.5	4.5
10	10	20.0	27.0	7.0
15	10	20.5	25.5	
20	10			
25	10	21.0	25.0	4.0

- (a) The thermometer readings for 20 cm^3 of hydrochloric acid are shown in Fig. 4.1.

Record in Table 4.1 these temperatures to the nearest 0.5°C .

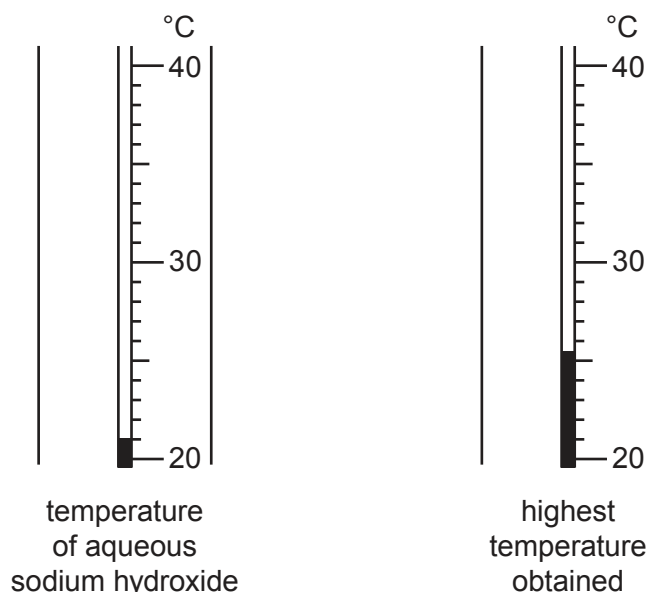

Fig. 4.1

(b) Calculate the temperature changes, ΔT , for 15 cm³ and 20 cm³ of dilute hydrochloric acid.

Write your answers in Table 4.1. [1]

(c) Identify the dependent variable in this investigation.

..... [1]

(d) (i) Plot a graph of the temperature change, ΔT (vertical axis), against the volume of dilute hydrochloric acid on the grid provided.

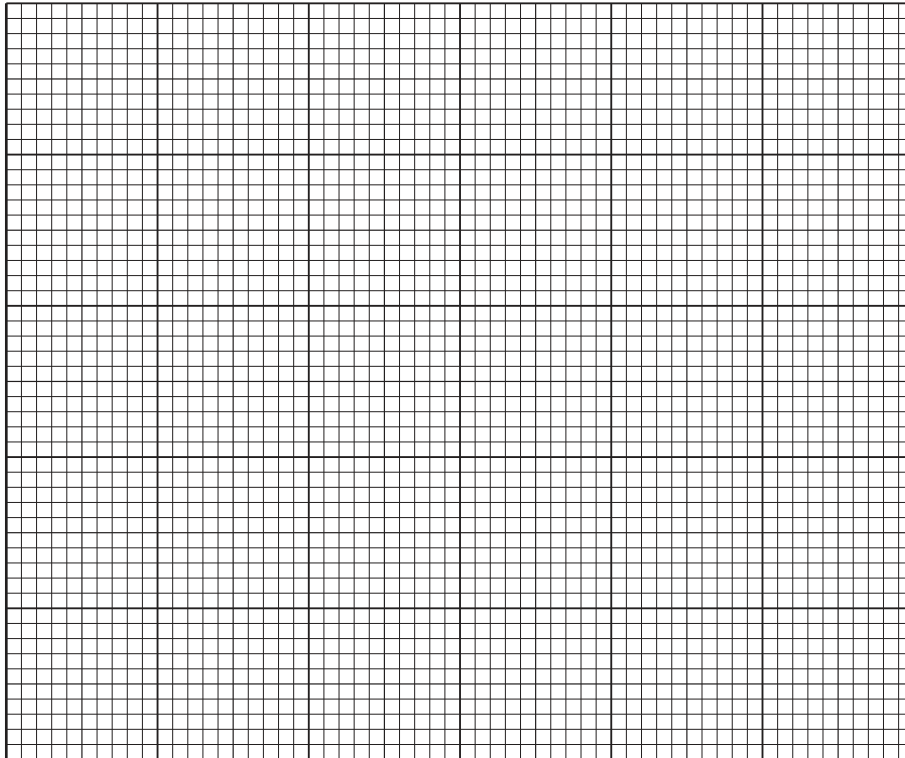

[3]

(ii) Draw the best-fit curve. [1]

(e) Use your graph to estimate the volume of dilute hydrochloric acid that gives the largest temperature change.

Show on your graph how you arrived at your answer.

..... cm³ [1]

(f) During the experiment the liquid in the beaker loses thermal energy to the surroundings.

(i) State the effect this will have on the results of the experiment.

.....
..... [1]

(ii) Suggest **one** way of reducing the loss of thermal energy in this experiment.

.....
..... [1]

(g) Give **one** advantage of using a 10 cm³ measuring cylinder to measure the volume of aqueous sodium hydroxide rather than a 25 cm³ measuring cylinder.

..... [1]

[Total: 12]

5 A student determines the density of the material from which a metre rule is made.

The student measures the width w and thickness t of the metre rule.

Fig. 5.1 shows the metre rule and Fig. 5.2 shows the **actual** size of the end of the metre rule.

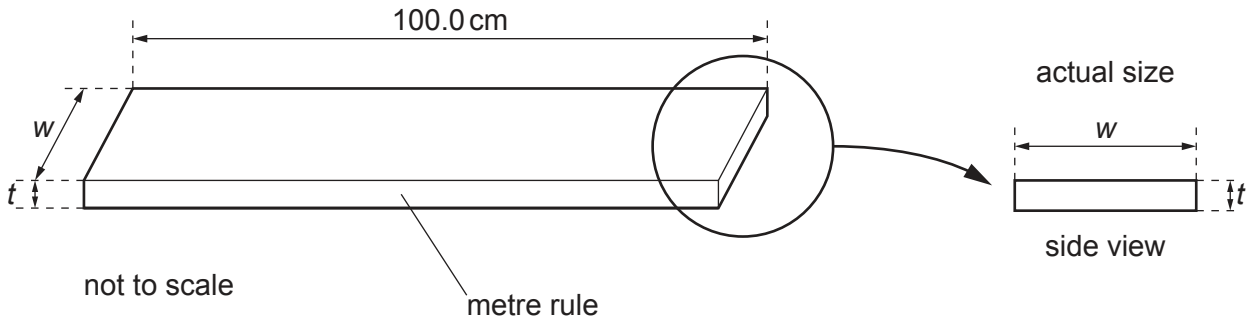

Fig. 5.1

Fig. 5.2

(a) (i) On Fig. 5.2 measure the width w of the metre rule to the nearest 0.1 cm.

$w = \dots\dots\dots$ cm [1]

(ii) On Fig. 5.2 measure the thickness t of the metre rule to the nearest 0.1 cm.

$t = \dots\dots\dots$ cm [1]

(iii) State which of your measurements, w or t , is the more accurate. Give a reason for your answer.

measurement

reason

..... [1]

(b) Calculate the volume V of the metre rule. Use the equation shown.

$$V = 100 \times w \times t$$

$V = \dots\dots\dots$ cm³ [1]

- (c) The student places a pivot directly under the 65.0 cm mark on the metre rule, so that the distance $d = 65.0$ cm, as shown in Fig. 5.3.

He places load m on the metre rule.

He adjusts the position of load m until the rule is as close to being balanced as possible.

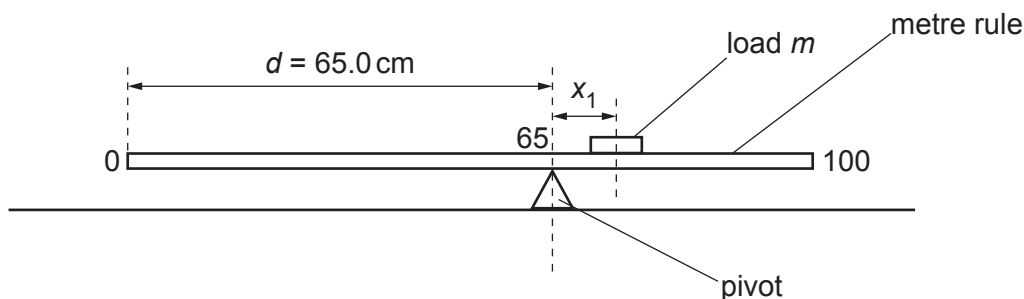

Fig. 5.3

He notes that the **centre** of load m is directly above the 74.2 cm mark on the metre rule.

- (i) Calculate the distance x_1 from the centre of load m to the pivot.

$x_1 = \dots\dots\dots$ cm [1]

- (ii) Describe how the student identifies the position of the centre of load m on the scale of the metre rule.

.....
 [1]

- (iii) The student moves the pivot until the distance $d = 70.0$ cm as shown in Fig. 5.4.

He adjusts the position of load m until the rule is as close to being balanced as possible.

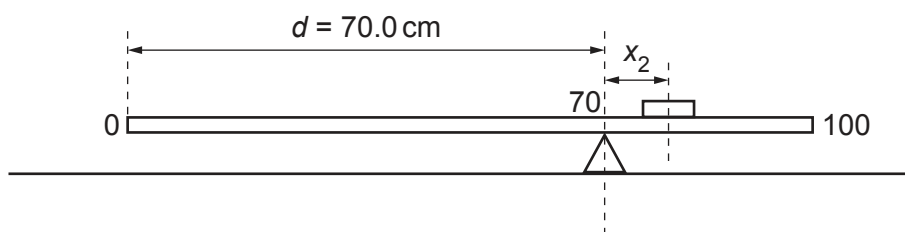

Fig. 5.4

He notes that the centre of load m is directly above the 82.3 cm mark on the metre rule.

Calculate the distance x_2 from the centre of load m to the pivot.

$$x_2 = \dots\dots\dots \text{ cm [1]}$$

(iv) Use the results for (c)(i) and (c)(iii) to calculate the mass M of the metre rule.

Use the equation shown.

$$M = 5.7 (x_1 + x_2)$$

$$M = \dots\dots\dots \text{ g [1]}$$

(d) (i) The value of M obtained in (c)(iv) is approximate.

State two practical difficulties involved in doing this experiment that makes the measured values of x_1 and x_2 subject to experimental error.

1

2

[2]

(ii) Suggest **one** way in which the student could check his value of M calculated in (c)(iv).

..... [1]

(e) Use your answers to (b) and (c)(iv) to calculate the density ρ of the material from which the rule is made.

Use the equation shown.

$$\rho = \frac{M}{V}$$

Give the unit for your answer.

$$\rho = \dots\dots\dots [1]$$

$$\text{unit} = \dots\dots\dots [1]$$

[Total: 13]

6 The rate of cooling of water in a beaker depends upon the volume of water in the beaker.

Plan an experiment to investigate how the rate of cooling of hot water depends upon the volume of the water.

The apparatus available is listed.

- thermometer**
- stop-watch**
- beaker**
- measuring cylinder**
- supply of hot water**

In your answer you should:

- explain briefly how you would do the experiment
- state the key variables you would control
- draw a table with column headings to show how you would present your results (you are not required to enter any readings in the table)
- explain how you would use your results to reach a conclusion.

.....

.....

.....

.....

.....

.....

.....

.....

.....

.....

.....

.....

.....

.....

..... [7]

[Total: 7]

BLANK PAGE

Permission to reproduce items where third-party owned material protected by copyright is included has been sought and cleared where possible. Every reasonable effort has been made by the publisher (UCLES) to trace copyright holders, but if any items requiring clearance have unwittingly been included, the publisher will be pleased to make amends at the earliest possible opportunity.

To avoid the issue of disclosure of answer-related information to candidates, all copyright acknowledgements are reproduced online in the Cambridge Assessment International Education Copyright Acknowledgements Booklet. This is produced for each series of examinations and is freely available to download at www.cambridgeinternational.org after the live examination series.

Cambridge Assessment International Education is part of the Cambridge Assessment Group. Cambridge Assessment is the brand name of the University of Cambridge Local Examinations Syndicate (UCLES), which itself is a department of the University of Cambridge.